

DME 150

150 Watts, 50 Volts, Pulsed
Avionics 1025 - 1150 MHz

GENERAL DESCRIPTION

The DME 150 is a high power COMMON BASE bipolar transistor. It is designed for pulsed systems in the frequency band 1025-1150 MHz. The device has gold thin-film metallization and diffused ballasting for proven highest MTTF. The transistor includes input and output prematch for broadband capability. Low thermal resistance package reduces junction temperature, extends life.

CASE OUTLINE 55AY, STYLE 1

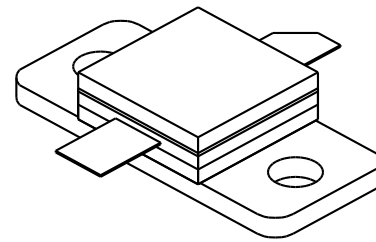

ABSOLUTE MAXIMUM RATINGS

Maximum Power Dissipation @ 25°C² 290 Watts

Maximum Voltage and Current

BVces Collector to Base Voltage 55 Volts
BVebo Emitter to Base Voltage 4.0 Volts
Ic Collector Current 15 Amps

Maximum Temperatures

Storage Temperature - 65 to + 150°C
Operating Junction Temperature + 150°C

ELECTRICAL CHARACTERISTICS @ 25 °C

SYMBOL	CHARACTERISTICS	TEST CONDITIONS	MIN	TYP	MAX	UNITS
Pout	Power Out	F = 1025-1150 MHz	150			Watts
Pin	Power Input	Vcc = 50 Volts			25	Watts
Pg	Power Gain	PW = 10 μsec	7.8	8.3		dB
ηc	Collector Efficiency	DF = 1%		40		%
VSWR	Load Mismatch Tolerance	F = 1090 MHz			20:1	

BVebo	Emitter to Base Breakdown	Ie = 15 mA	4.0			Volts
BVces	Collector to Emitter Breakdown	Ic = 25 mA	55			Volts
Cob	Capacitance Collector to Base	Vcb = 50 Volts				pF
hFE	DC - Current Gain	Ic = 250 mA, Vce = 5 V	20			
θjc ²	Thermal Resistance				0.6	°C/W

Note 1: At rated output power and pulse conditions
2: At rated pulse conditions

Initial Issue June 1, 1994

GHZ TECHNOLOGY INC. RESERVES THE RIGHT TO MAKE CHANGES WITHOUT FURTHER NOTICE. GHZ RECOMMENDS THAT BEFORE THE PRODUCT(S) DESCRIBED HEREIN ARE WRITTEN INTO SPECIFICATIONS, OR USED IN CRITICAL APPLICATIONS, THAT THE PERFORMANCE CHARACTERISTICS BE VERIFIED BY CONTACTING THE FACTORY.

POWER OUTPUT

Vcc = 50 V, Pin = 25 W

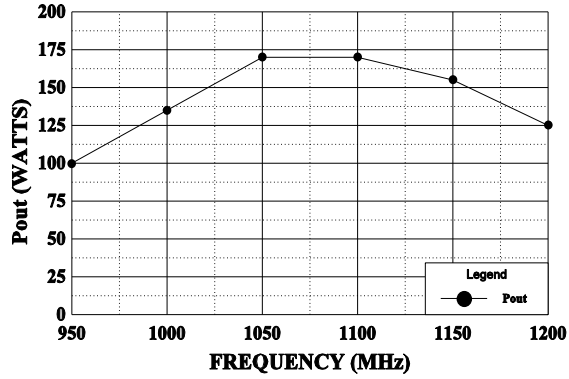

THERMAL RESISTANCE vs PULSE WIDTH

Vcc=50V, DF=1%, Tf=30C

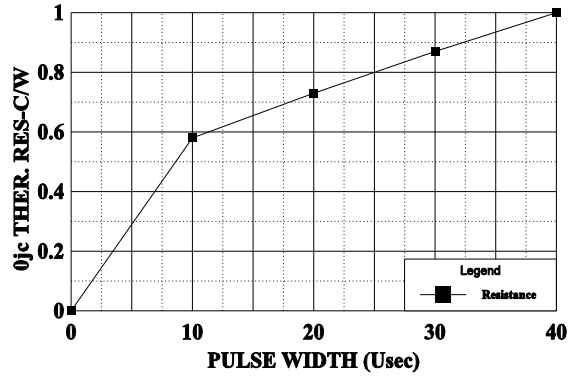

SERIES INPUT IMPEDANCE vs FREQUENCY

Vcc = 50 V, Po = 150 W

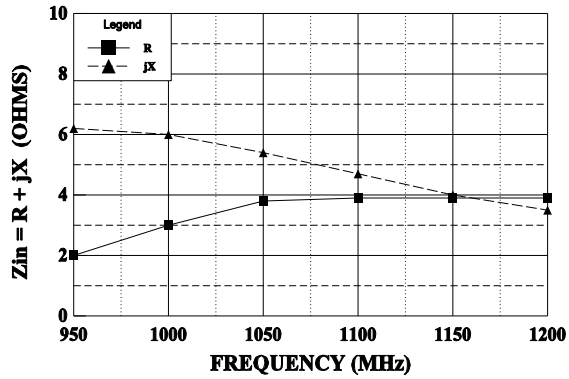

SERIES LOAD IMPEDANCE vs FREQUENCY

Vcc = 50 V, Po = 150 W

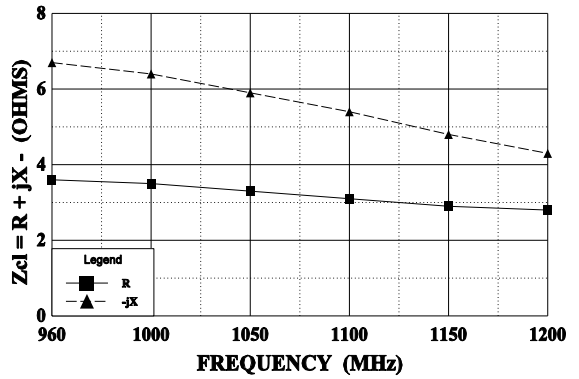

REVISIONS

ZONE	REV	DESCRIPTION	DATE	APPROVED
------	-----	-------------	------	----------

DIM	INCHES
A	2.000
B	1.500
C	.700
D	.550
E	.628
F	.200
G	.140
H	.028
I	.180
J	.284
K	.200
L	.166
M	.350
N	.528
O	.050
P	.150
Q	.028
R	.300
S	.419
T	.130

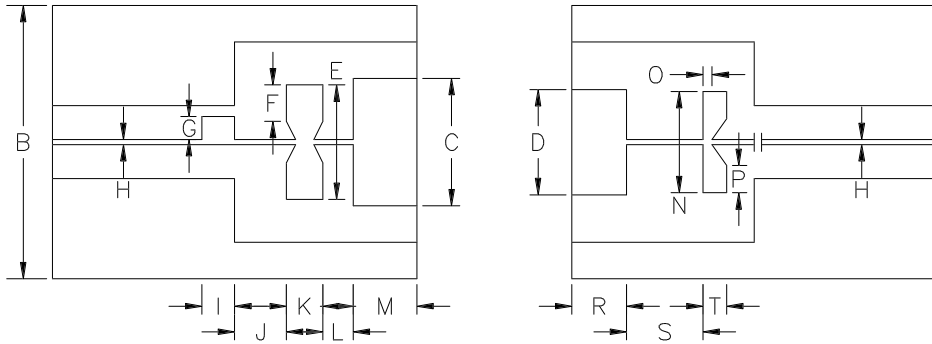

1025/1150 MHz TEST AMPLIFIER

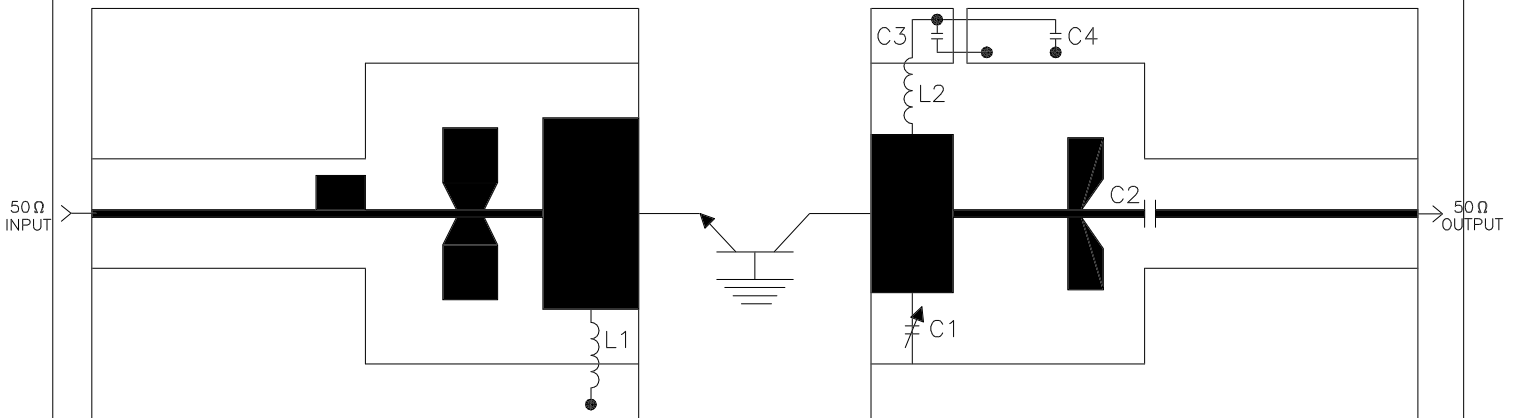

Material=.010" Duroid Er=2.3

- L1= 1" No. 20 wire
- L2= 7 turns No. 20 wire, closewound 1/8" dia.
- C1= Johanson No. 5701, 6-6PF
- C2= A.T.C. Chip cap. 82PF
- C3= A.T.C. Chip cap. 92PF
- C4= 200 MFD @ 50V



CAGE OPJR2	DWG NO. DME 150	REV A
SCALE 1/1	SHEET	